

**180-8.3STP-\_\_**

Floor Mounted Bath Set with Hand Shower and Shut-Off Valves

Does not use concealed rough

Hand Shower Flow Rate: 1.75 GPM

Note: Some building codes require remote pressure balance valves for anti-scald

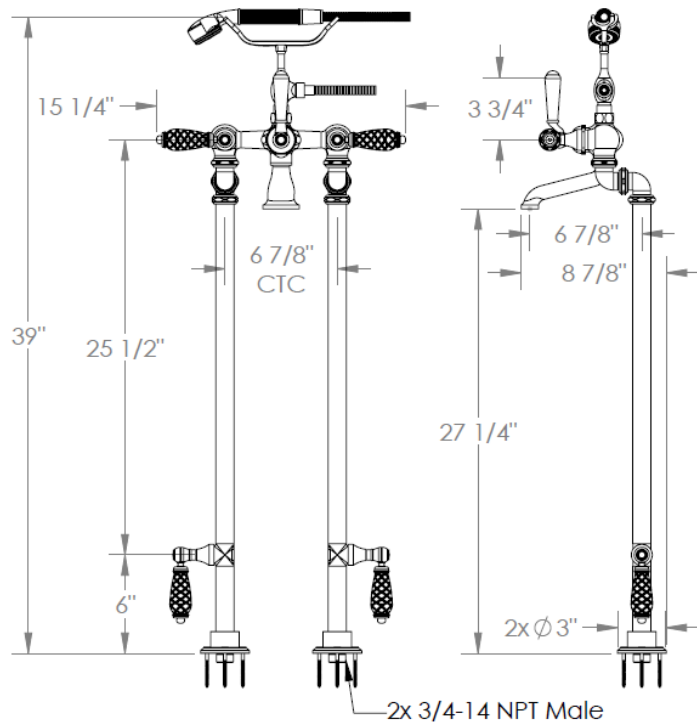

Meets the applicable requirements of ASME A112.18.1-2005/CSA B125.1-05, entitled "Plumbing Supply Fittings"

## HANDLE TRIM OPTIONS

AA - VENICE  
BB - GENOA

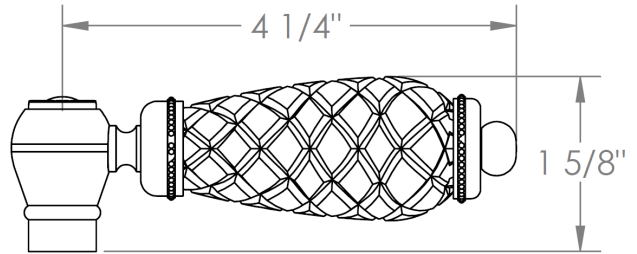
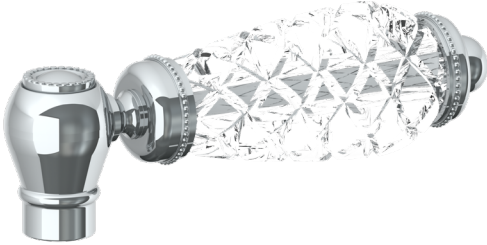

CC - POMPEI  
DD - NAPLES

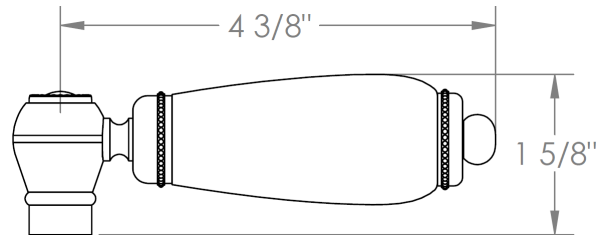
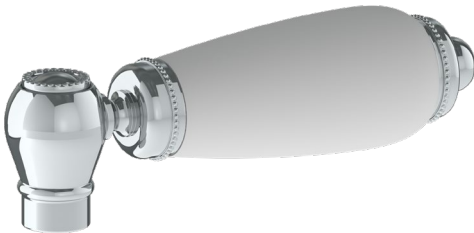

SWU - FLORENCE

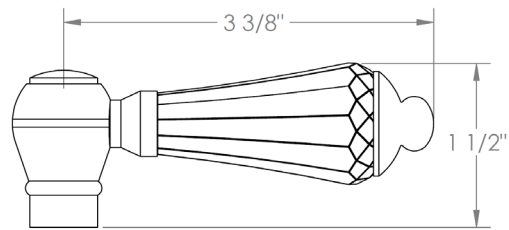
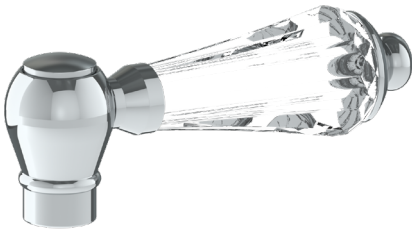

T - TUSCANY

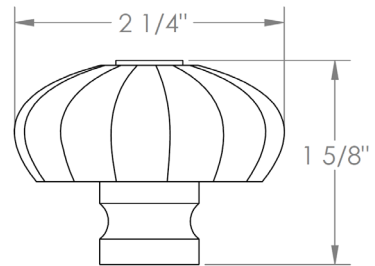

U - BOLOGNA

