

PART NO. D3619A

SPECIFICATION SHEET

Brass 1/2 in. IPS Shower Arm and flange

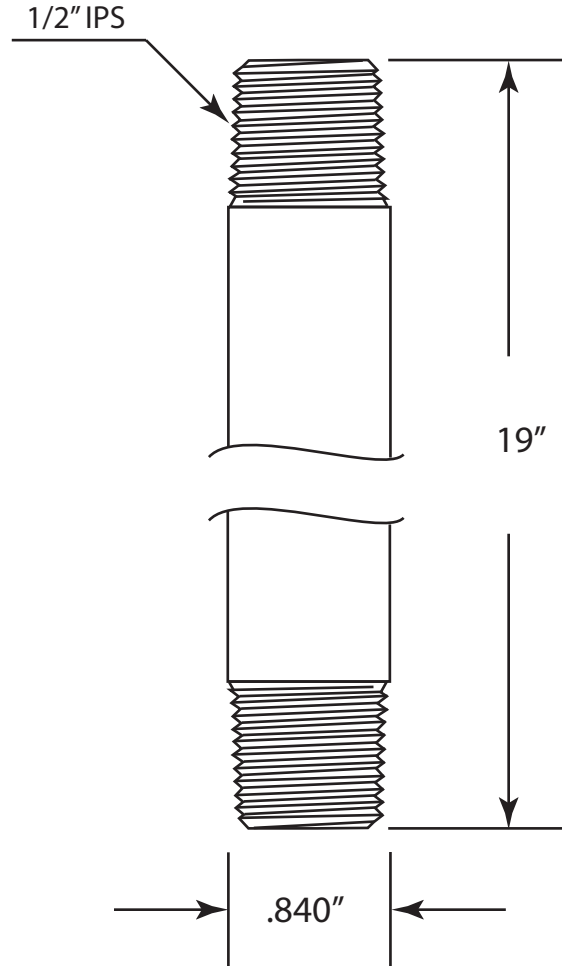
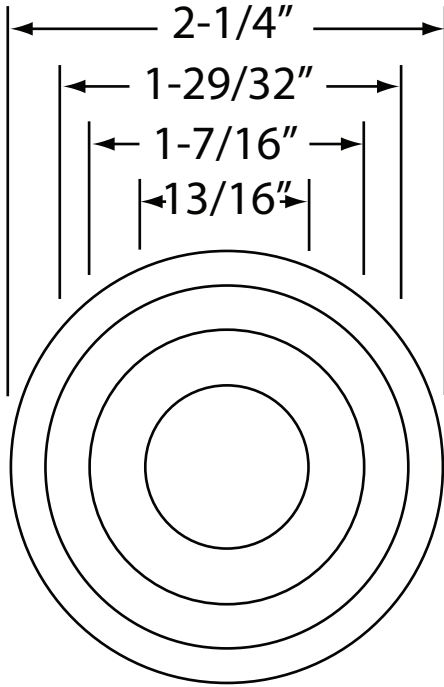

0.109" Wall Thickness

