

Features

- 60"L x 32"W x 18-1/4"H
- The only two-person bath that fits into a standard 5' alcove
- Drop-in, three-wall alcove or undermount installation
- Constructed KOHLER® Cast Iron
- Designed for two-person bathing

Additional Hydrotherapy Options

- Soaking Bath - K-850-0
- BubbleMassage air bath - K-852-G0
- Whirlpool - K-852-H2

Required Products/Accessories

K-7169-AF 1-1/2" Contoured Pop-up Drain

Recommended Products/Accessories

K-586 Under-Mount Installation Kit
 K-1172 Adjustable feet
 K-1179 Vinyl Tiling-in Bead
 K-1491 Bath/Whirlpool Pillow
 K-1601 Bath/Whirlpool Footstop
 K-702200-G54 Frameless Sliding Bath Door
 K-702200-G73 Frameless Sliding Bath Door
 K-702200-L Frameless Sliding Bath Door
 K-702205-L Frameless Sliding Bath Door
 K-706000-D3 Frameless Sliding Bath Door
 K-706000-L Frameless Sliding Bath Door
 K-706003-L Frameless Sliding Bath Door
 K-706004-D3 Frameless Sliding Bath Door
 K-706004-L Frameless Sliding Bath Door
 K-706007-L Frameless Sliding Bath Door



ADA

Codes/Standards













ASME A112.19.1/CSA B45.2
 ASTM F462
 ADA
 ICC/ANSI A117.1

KOHLER® Enameled Cast Iron Bath and Shower Base Lifetime Limited Warranty

See website for detailed warranty information.

Available Colors/Finishes

Color tiles intended for reference only.

| Color | Code | Description |
|--|------|---------------|
|  | 0 | White |
|  | 96 | Biscuit |
|  | 47 | Almond |
|  | NY | Dune |
|  | 95 | Ice™ Grey |
|  | G9 | Sandbar |
|  | 33 | Mexican Sand™ |
|  | K4 | Cashmere |
|  | 58 | Thunder™ Grey |
|  | 7 | Black Black™ |
|  | GRL | Grey Lavender |
|  | DGB | Indigo Blue |
|  | PLM | Black Plum |

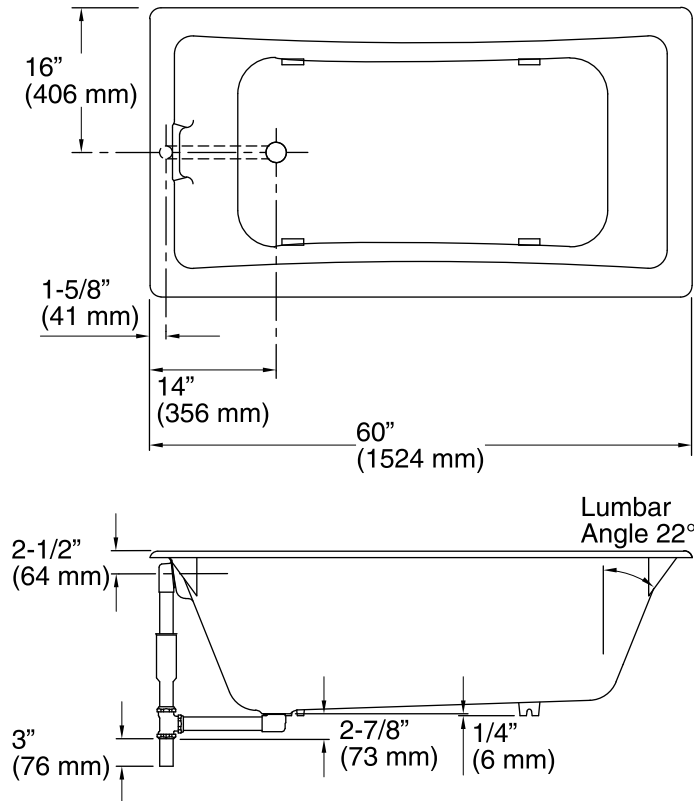

No change in measurements if connected with drain illustrated. (K-7169-AF)

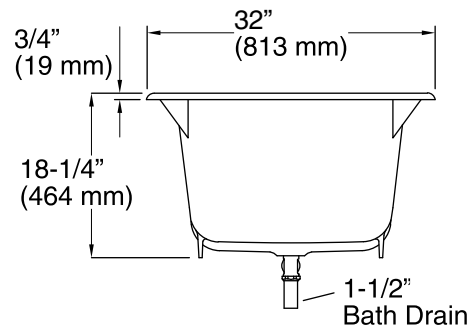

Technical Information

All product dimensions are nominal.

| | |
|------------------------|---|
| Installation: | Drop-in, Under-mount, Three-wall alcove |
| Drain location: | End |
| Basin area, bottom: | 40-1/2" x 20" (1029 mm x 508 mm) |
| Basin area, top: | 52-3/4" x 24" (1340 mm x 610 mm) |
| Weight: | 250 lbs (113.4 kg) |
| Minimum floor load: | 58 lbs/ft ² (283.2 kg/m ²) |
| Water depth: | 13-5/8" (346 mm) |
| Water capacity: | 60 gal (227.1 L) |
| Cutout: | Drop-in, 58-1/2" x 30-1/2" (1486 mm x 775 mm) |
| Template: | Under-mount, K-586, required, not included |
| Minimum flat for door: | 2-1/4" (57 mm) |

Notes

Measure your actual product for rough-in details. Install this product according to the installation instructions.

The hot water supply should be 70% of the capacity of the bath or greater. Installations will vary.

Kit is required for under-mount installations (sold separately).

ADA compliant when installed to the specific requirements of these regulations.