

Royal Lumos
14302171351 Mirror cabinet

PRODUCT

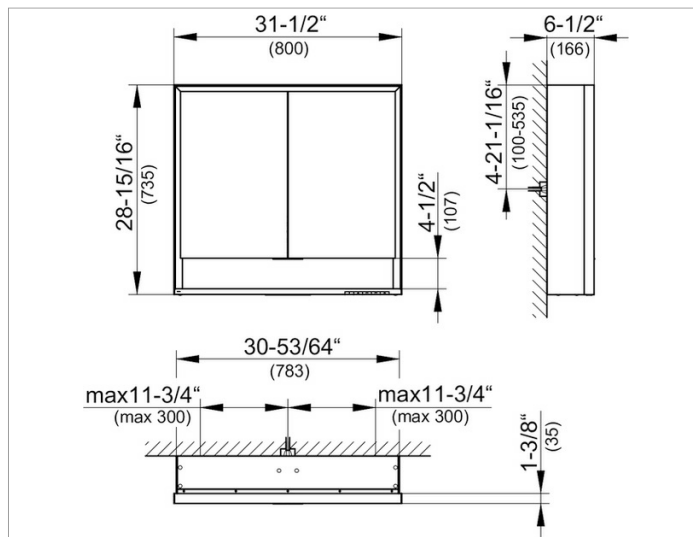

DRAWING



PRODUCT ATTRIBUTES

wall mounted,
 adjustable light color from 2700 kelvin (warm white) to 6500 kelvin (daylight),
 2 hinged double sided crystal mirrored doors,
 Body: aluminum silver anodized
 Body panels and interior rear wall mirrored
 Operation:
 key panel with capacitive touch sensor,
 integrated extension function for e.g. light switch
 Illumination:
 frame lighting and washbasin/shelf light separately,
 infinitely dimmable and can be switched on/off
 LED 56 watt (lifespan > 30.000 hours)
 EEK: A++, A+, A , 56 kWh/1000h

EQUIPMENT

- 2 sockets
- 2 x 2 adjustable glass shelves
- storage space across full width
- soft-closing doors

SURFACE

silver anodized

DIMENSION

31,5 x 28,94 x 6,5 "

SPECIFICATIONS

KEUCO Royal Lumos Mirror cabinet 14302171351
 High quality Mirror cabinet in elegant design

wall mounted,
 adjustable light colour from 2700 kelvin (warm white) to 6500 kelvin (daylight),
 2 hinged double sided crystal mirrored doors,
 Body: aluminium silver anodized
 Body panels and interior rear wall mirrored

Operation:
 key panel with capacitive touch sensor,
 integrated extension function for e.g. light switch

Illumination:
 frame lighting and washbasin/shelf light separately,
 infinitely dimmable and can be switched on/off
 LED 56 watt (lifespan > 30.000 hours)
 infinitely dimmable, lamps non-exchangeable

- 2 sockets
- 2 x 2 adjustable glass shelves
- storage space across full width
- soft-closing doors

31-1/2" x 28-15/16" x 6-1/2"

silver anodized

Warranty: KEUCO products are covered by a 5-year manufacturer's warranty, in effect from the date of purchase. During this time, proven product defects will be remedied free of charge. Warranty claims must be filed in writing, including a detailed description of the defect immediately after a defect has occurred. For a copy of our detailed product warranty policy, please contact us at office-usa@keuco.com.

Installation: KEUCO products must be installed by a qualified professional in accordance with the respective installation guidelines and any applicable federal / local building codes and regulations.