

CIRCO COLLECTION

TOWEL BAR 9"

365109

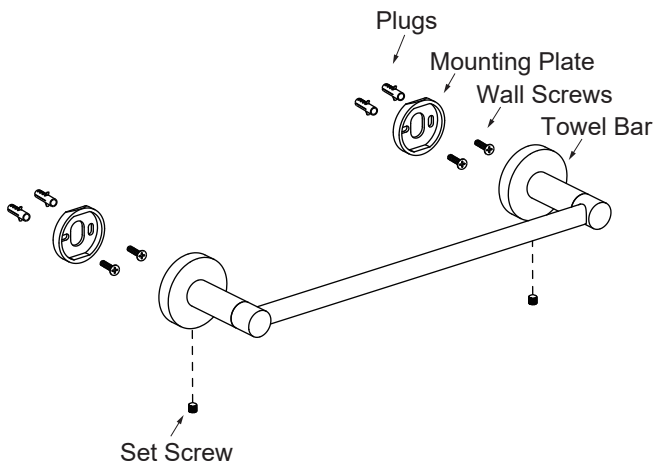

Tools required for installation

Level	Pencil
Screwdriver	Drill
	Hammer

Step 1

Loosen the set screw on the accessory and remove the backing plates. Position the accessory against the wall and mark outline with pencil.

Step 2

Position the backing plates flat side down on the wall and mark holes with pencil.

Step 3

Predrill 3/16" holes on the wall to fit wall plugs. Insert wall plugs into the wall. Position backing plates flat side down over the plugs and install screws.

Step 4

Slide the accessory onto the backing plates and tighten the set screws using Allen key provided.