

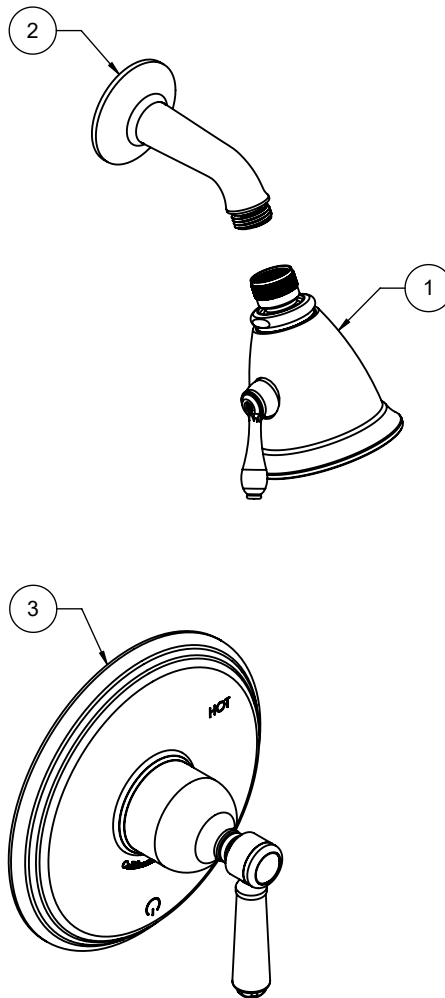

"ZZ" denotes finish, "FR" denotes flow rate

Item	Model	Description	Links
1	SH-04T.FR-ZZ	3-5/16" 6 Jet Showerhead	Specification Sheet
2	SH-01-ZZ	One Piece 4" Shower Arm & Flange	Specification Sheet
3	TO-PBL-33-ZZ	Pressure Balance Trim Only	Specification Sheet





California Faucets®

Showerhead

3-5/16" 6 JETS

Features

- 1/2" FIP inlet
- Brass construction
- 3-5/16" diameter
- Replace .FR with desired max flow rate:
 - SH-04T.25 for 2.5 gpm
 - SH-04T.20 for 2.0 gpm
 - SH-04T.18 for 1.8 gpm
 - SH-04T.15 for 1.5 gpm

SH-04T.25
 SH-04T.20
 SH-04T.18
 SH-04T.15



Codes/Standards

Product meets or exceeds the following:

- ASME A112.18.1/CSA B125.1
- CEC (1.8 & 1.5 gpm)
- DOE (2.5, 2.0, 1.8, & 1.5 gpm)
- Commonwealth of MA
- EPA WaterSense (2.0 & 1.5 gpm)

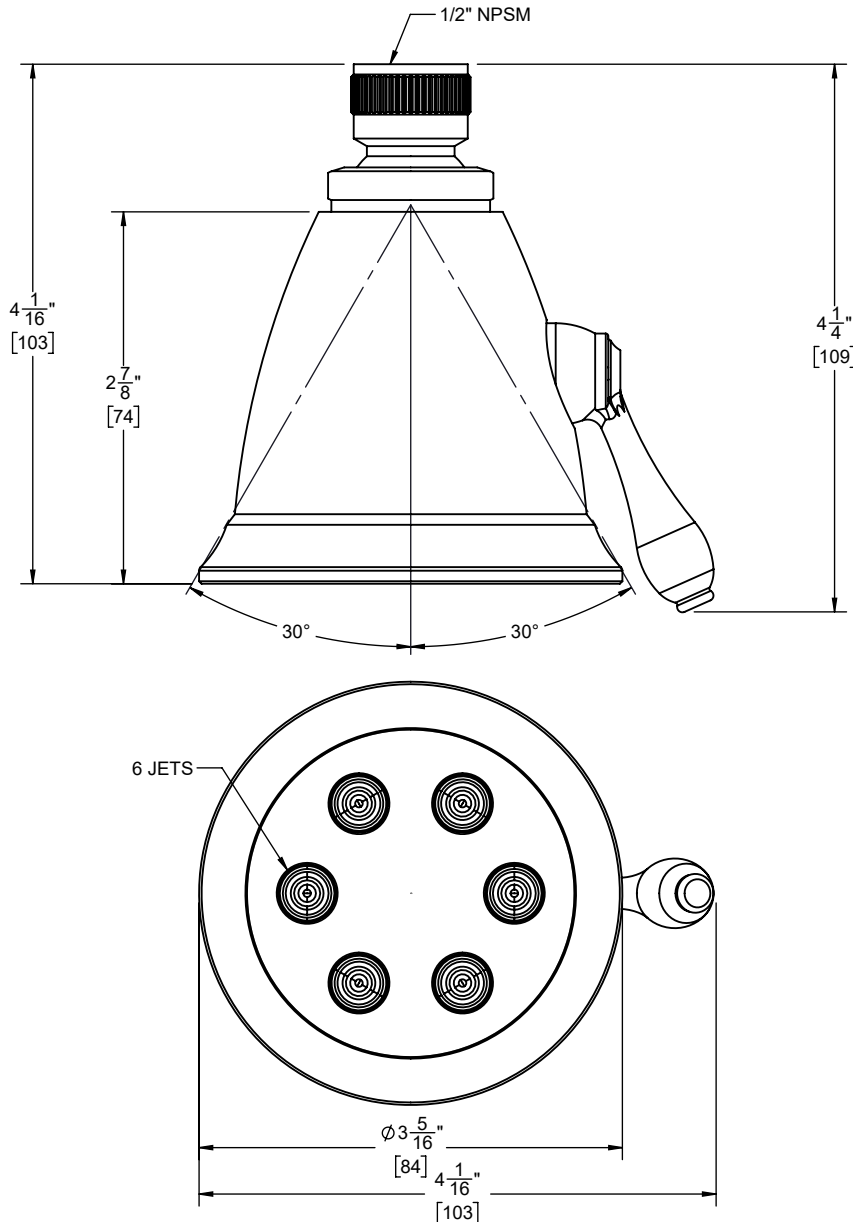

SPECIFICATIONS SUBJECT TO CHANGE WITHOUT NOTICE

DIMENSIONS SHOWN TO NEAREST 1/16"
[DIMENSIONS SHOWN TO NEAREST 1MM]

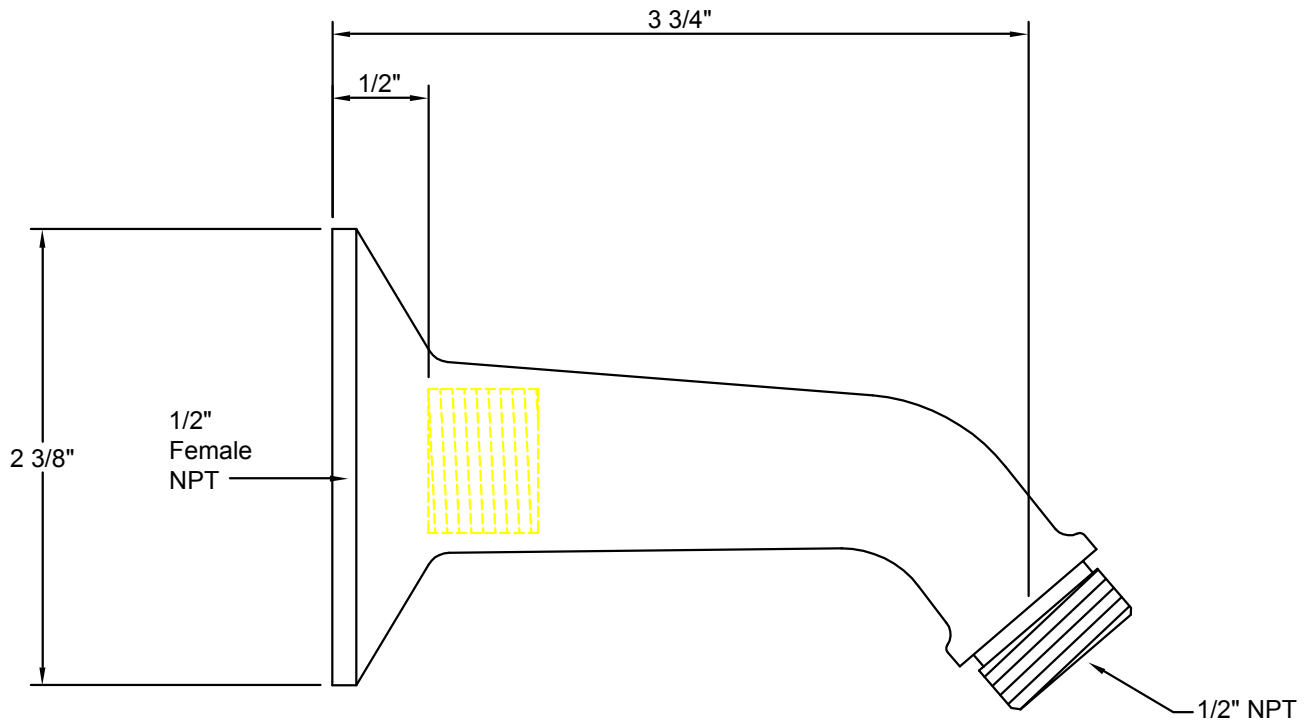

A Division of
California Faucets

Decorative Trim for Bath & Kitchen
info@calfaucets.com
www.calfaucets.com

5231 Argosy Drive
Huntington Beach, CA 92649

Tel: 714-891-7797
Fax: 714-891-2478
Toll Free: 800-822-8855

Fixture:

SH-01

Revision date: April 1, 2005

Date: October 1, 2004

Scale: None

Drawn by: William Linares
william@calfaucets.com

Technical Supervisor: Joe Mainberger



California Faucets®

Pressure Balance™

1/2" Pressure Balance Valve Trim Only

Features

- Over 30 finishes including 11 PVD finishes
- All brass construction
- Traditional or contemporary escutcheon and screwless faceplate
- Handles to match all California Faucets series
See www.calfaucets.com for complete selection

TO-PBL-XX

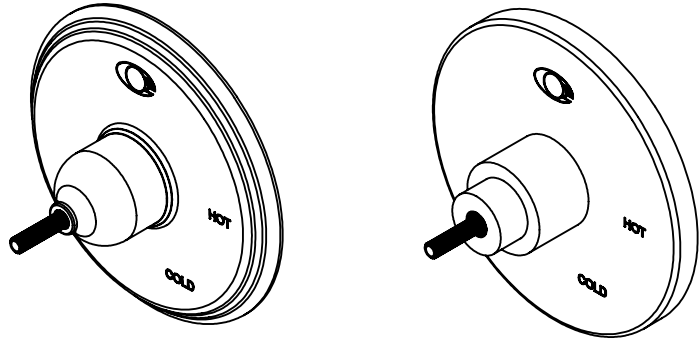

Codes/Standards Applicable

Specified model meets or exceeds the following:

- ASME A112.18.1-2005/CSA B125.1-05
- ASSE 1016
- ADA (with lever handles)
- Listed IAPMO/UPC®

XX = Series Handle

Traditional

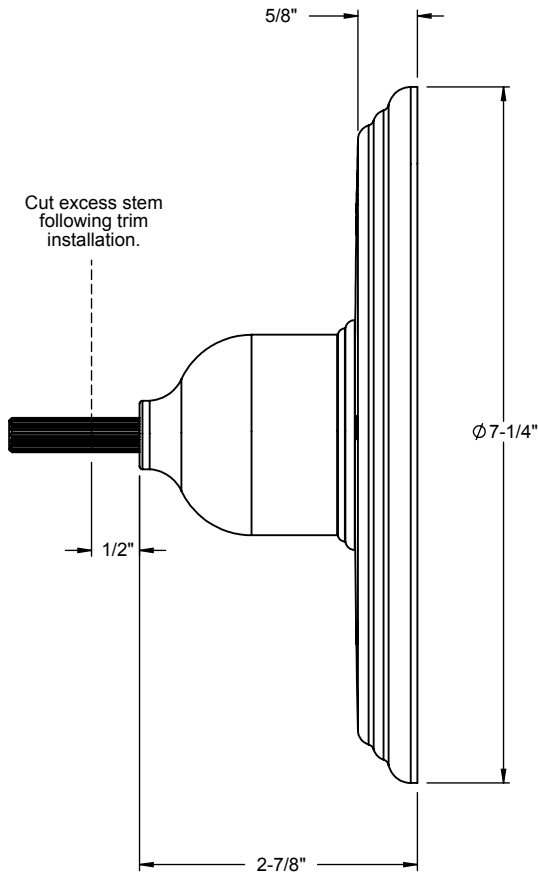

Contemporary

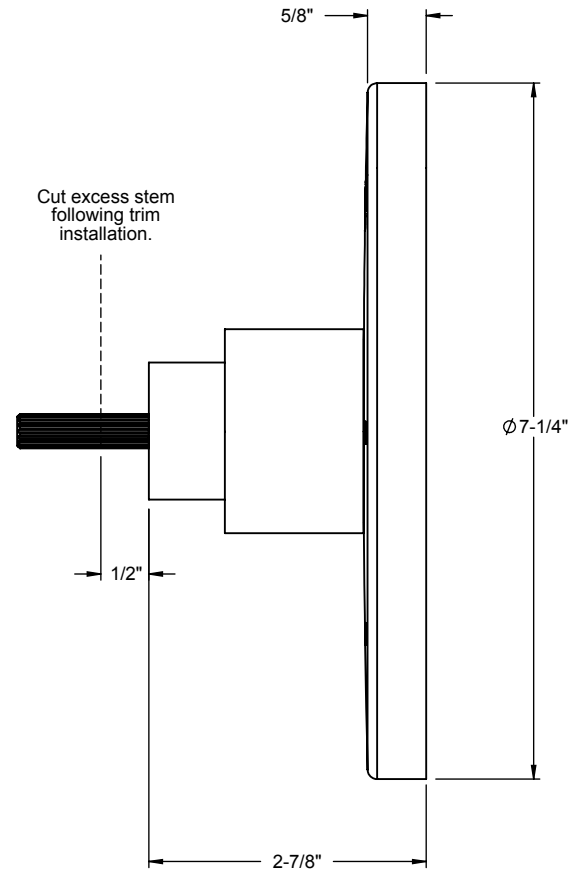

ALL DIMENSIONS SHOWN TO NEAREST 1/16"

Replacement Parts

TO-PBL-XX

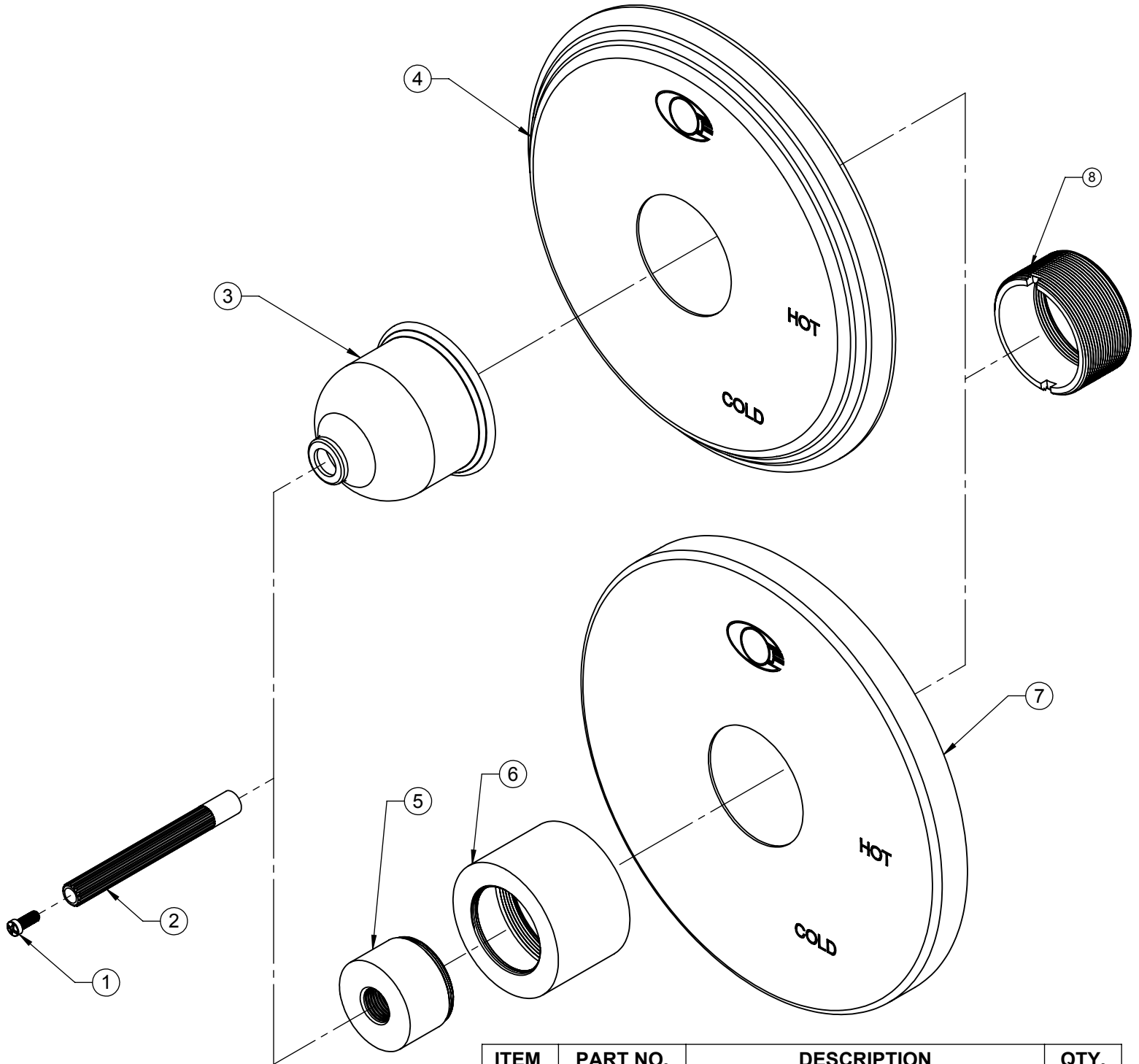

ITEM	PART NO.	DESCRIPTION	QTY.
1	86078-90	SCREW,PH, M4X.07X10MM	1
2	881290-99	BROACH,16 PT. X 3-1/4"	1
3	10293-ZZ	ESCUTCHEON, TRAD, PBL	1
4	7-100105-ZZ	ASM, TRAD PB PLATE & GASKET	1
5	571380-ZZ	ESCUTCHEON, 57	1
6	10294-ZZ	ESCUTCHEON, CONT, PBL	1
7	7-100106-ZZ	ASM, CONT PB PLATE & GASKET	1
8	10292-98	BUSHING, PBL	1