

27-6.1-CL14

Wall Mounted Exposed Shower

Flow Rate: 1.75 GPM

Note: Some building codes require remote pressure balance valves for anti-scald

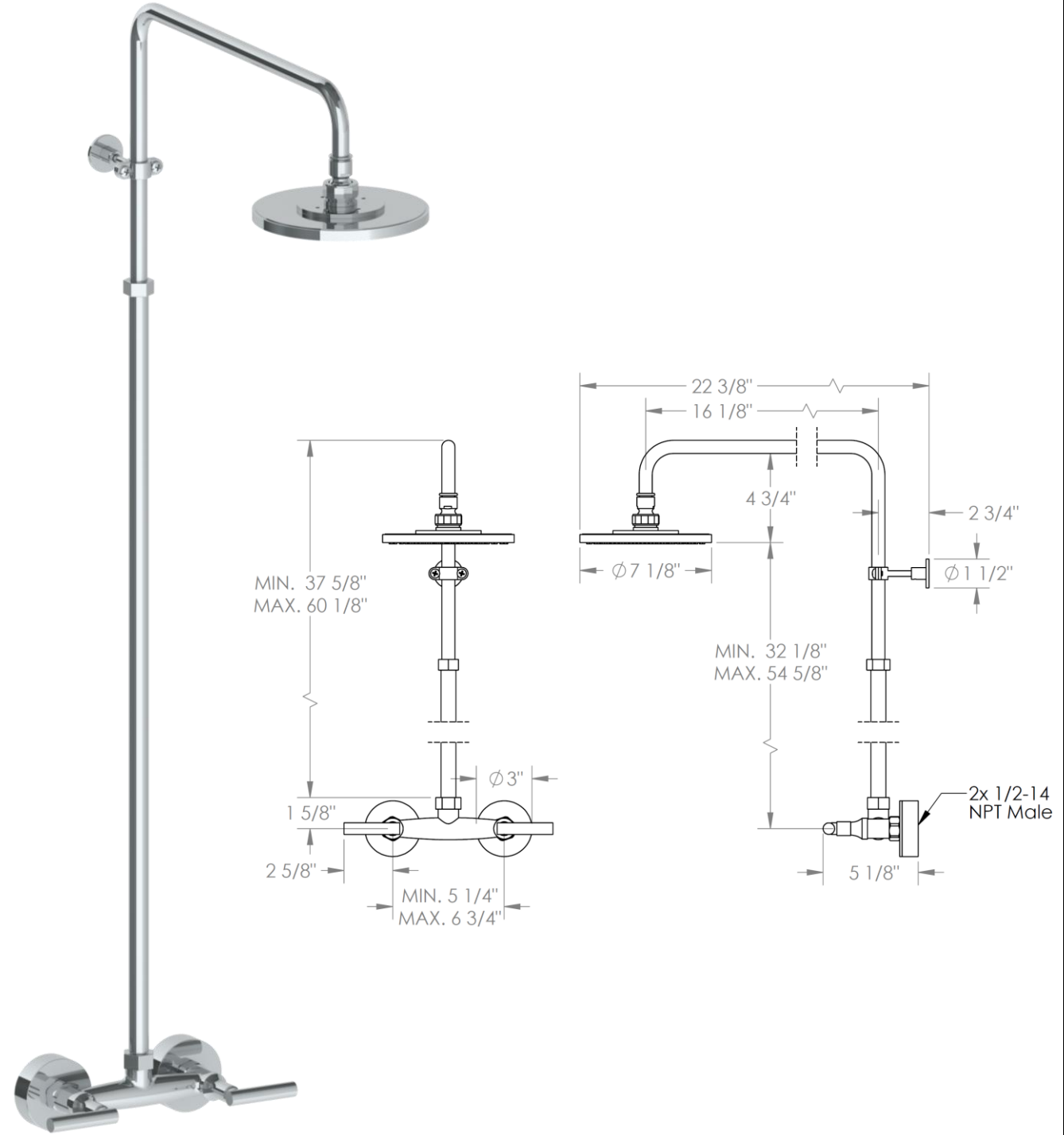

Meets the applicable requirements of ASME A112.18.1-2005/CSA B125.1-05, entitled "Plumbing Supply Fittings"